



FOREGALLE

ROOFING & REINFORCEMENT SPECIALISTS



ROOFING & CLADDING



QUALITY
CLADDING,
AFFORDABLE
PRICES



CONTENTS.

FORECLAD®	03
R	
RS	
RT	
FORECLAD®	05
W	
WS	
WT	
FORECLAD®	07
FL	
WL	
DOUBLE SKIN SYSTEMS	
ROOFLIGHTS	08
THERMOCLAD®	09
FLASHINGS	10
WHAT WE OFFER	
FLAT STEEL SHEETS	
GUTTER SOLUTIONS	
DR!PSTOP	12
ADVANTAGES	
HOW DOES DR!PSTOP WORK?	
SHEETING RAILS	13
PURLINS	
MINI Z SPACER BAR	
CLEAT DETAIL	
FIBRE CEMENT	15
ACCESSORIES	16
FIXINGS	
FOAM FILLERS	
INSULATION	
SEALANTS	
PROFILE MATCHING	17

R.

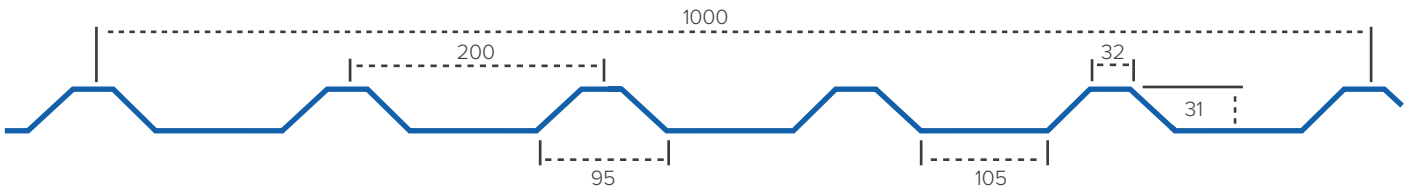

* Please Note: This is a standard roof profile.

RS.

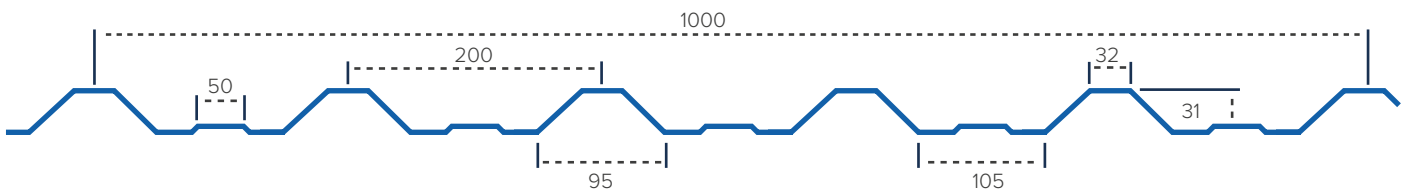

RT.

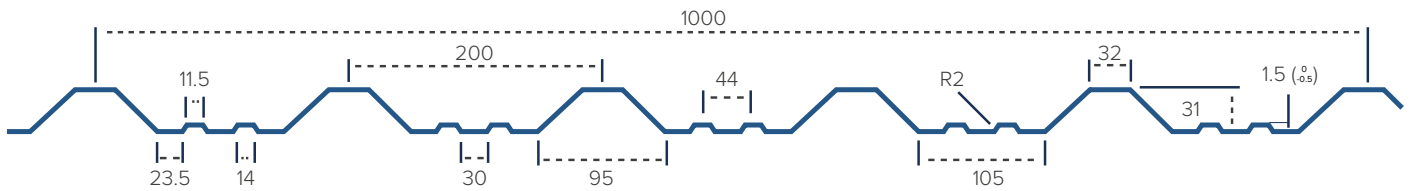

DETAILS.

DIMENSION DETAILS	
COVER WIDTH	1000mm
PROFILE PITCH	200mm
PROFILE DEPTH	31mm
CROWN WIDTH	32mm
VALLEY WIDTH	105mm
RIB WIDTH	95mm



WEIGHT PER LINEAR METRE	
0.7mm	6.70 kg
0.5mm	4.79 kg

SAFE WORKING LOAD (ULTIMATE / 1.5)																			
		SPAN (M)																	
GRAVITY	L/200	THICKNESS	1.00	1.10	1.20	1.30	1.40	1.50	1.60	1.70	1.80	1.90	2.00	2.10	2.20	2.30	2.40	2.50	2.60
	SINGLE SPAN	0.7	6.11	5.05	4.24	3.61	3.12	2.62	2.16	1.80	1.52	1.29	1.11	0.96	0.83	0.73	0.64	0.57	0.50
	DOUBLE SPAN	0.7	3.30	2.87	2.52	2.23	1.99	1.78	1.61	1.46	1.34	1.22	1.13	1.04	0.96	0.89	0.83	0.78	0.73
	MULTI SPAN	0.7	3.92	3.41	3.00	2.66	2.38	2.14	1.93	1.76	1.61	1.47	1.36	1.25	1.16	1.08	1.01	0.94	0.88
	SINGLE SPAN	0.5	3.10	2.82	2.59	2.24	1.93	1.68	1.42	1.18	1.00	0.85	0.73	0.63	0.55	0.48	0.56	0.37	0.33
	DOUBLE SPAN	0.5	1.81	1.58	1.39	1.24	1.11	1.00	0.91	0.83	0.76	0.69	0.64	0.59	0.55	0.51	0.48	0.45	0.42
	MULTI SPAN	0.5	2.14	1.87	1.65	1.47	1.32	1.19	1.08	0.99	0.91	0.83	0.77	0.71	0.66	0.62	0.58	0.54	0.51

SAFE WORKING LOAD (ULTIMATE / 1.5)																			
		SPAN (M)																	
SUCTION	L/200	THICKNESS	1.00	1.10	1.20	1.30	1.40	1.50	1.60	1.70	1.80	1.90	2.00	2.10	2.20	2.30	2.40	2.50	2.60
	SINGLE SPAN	0.7	5.66	4.68	3.93	3.26	2.61	2.12	1.75	1.46	1.23	1.04	0.89	0.77	0.67	0.59	0.52	0.46	0.50
	DOUBLE SPAN	0.7	3.42	2.97	2.61	2.32	2.07	1.86	1.68	1.53	1.40	1.28	1.18	1.09	1.01	0.94	0.86	0.78	0.73
	MULTI SPAN	0.7	4.05	3.53	3.11	2.76	2.47	2.23	2.02	1.84	1.68	1.54	1.42	1.29	1.12	0.98	0.86	0.94	0.84
	SINGLE SPAN	0.5	3.10	2.82	2.42	2.06	1.71	1.39	1.14	0.95	0.80	0.68	0.59	0.51	0.44	0.39	0.34	0.37	0.33
	DOUBLE SPAN	0.5	1.87	1.64	1.45	1.29	1.16	1.04	0.95	0.86	0.79	0.73	0.67	0.62	0.58	0.54	0.50	0.45	0.42
	MULTI SPAN	0.5	2.21	1.94	1.71	1.53	1.37	1.24	1.13	1.03	0.94	0.87	0.80	0.75	0.69	0.64	0.56	0.54	0.51

W.

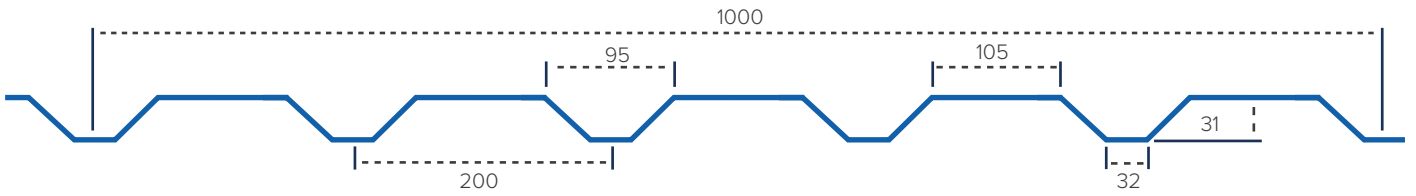

* Please Note: This is a standard wall profile.

WS.

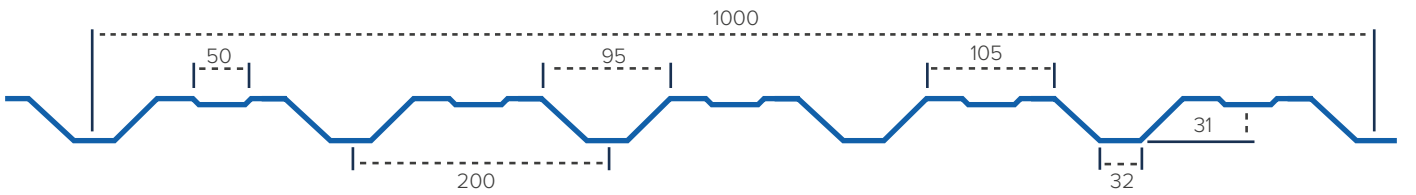

WT.

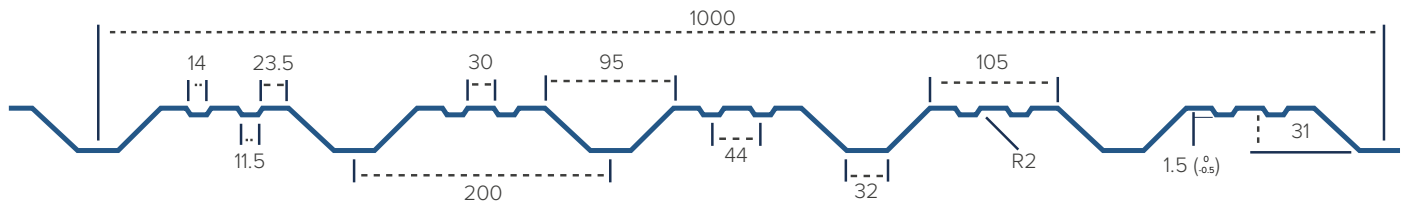

DETAILS.

DIMENSION DETAILS	
COVER WIDTH	1000mm
PROFILE PITCH	200mm
PROFILE DEPTH	31mm
CROWN WIDTH	32mm
VALLEY WIDTH	105mm
RIB WIDTH	95mm

WEIGHT PER LINEAR METRE	
0.7mm	6.70 kg
0.5mm	4.79 kg



SAFE WORKING LOAD (ULTIMATE / 1.5)																			
		SPAN (M)																	
	L/200	THICKNESS	1.00	1.10	1.20	1.30	1.40	1.50	1.60	1.70	1.80	1.90	2.00	2.10	2.20	2.30	2.40	2.50	2.60
POSITIVE PRESSURE	SINGLE SPAN	0.7	5.66	4.68	3.93	3.35	2.89	2.51	2.21	1.94	1.64	1.39	1.19	1.03	0.90	0.78	0.69	0.61	0.54
	DOUBLE SPAN	0.7	3.42	2.97	2.61	2.32	2.07	1.86	1.68	1.53	1.40	1.28	1.18	1.09	1.01	0.94	0.88	0.82	0.77
	MULTI SPAN	0.7	4.05	3.53	3.11	2.76	2.47	2.23	2.02	1.84	1.68	1.54	1.42	1.31	1.22	1.13	1.06	0.99	0.91
	SINGLE SPAN	0.5	3.10	2.82	2.42	2.06	1.78	1.55	1.36	1.21	1.07	0.91	0.78	0.67	0.59	0.51	0.45	0.40	0.36
	DOUBLE SPAN	0.5	1.87	1.64	1.45	1.29	1.16	1.04	0.95	0.86	0.79	0.73	0.67	0.62	0.58	0.54	0.50	0.47	0.44
	MULTI SPAN	0.5	2.21	1.94	1.71	1.53	1.37	1.24	1.13	1.03	0.94	0.87	0.80	0.75	0.69	0.65	0.60	0.57	0.53

SAFE WORKING LOAD (ULTIMATE / 1.5)																			
		SPAN (M)																	
	L/200	THICKNESS	1.00	1.10	1.20	1.30	1.40	1.50	1.60	1.70	1.80	1.90	2.00	2.10	2.20	2.30	2.40	2.50	2.60
SUCTION	SINGLE SPAN	0.7	6.11	5.05	4.24	3.61	3.12	2.71	2.39	2.11	1.88	1.69	1.47	1.27	1.11	0.97	0.85	0.76	0.67
	DOUBLE SPAN	0.7	3.30	2.87	2.52	2.23	1.99	1.78	1.61	1.46	1.34	1.22	1.13	1.04	0.96	0.89	0.83	0.78	0.73
	MULTI SPAN	0.7	3.92	3.41	3.00	2.66	2.38	2.14	1.93	1.76	1.61	1.47	1.36	1.25	1.16	1.08	1.01	0.94	0.88
	SINGLE SPAN	0.5	3.10	2.82	2.59	2.24	1.93	1.68	1.48	1.31	1.17	1.05	0.95	0.84	0.73	0.64	0.56	0.50	0.44
	DOUBLE SPAN	0.5	1.81	1.58	1.39	1.24	1.11	1.00	0.91	0.83	0.76	0.69	0.64	0.59	0.55	0.51	0.48	0.45	0.42
	MULTI SPAN	0.5	2.14	1.87	1.65	1.47	1.32	1.19	1.08	0.99	0.91	0.83	0.77	0.71	0.66	0.62	0.58	0.54	0.51

FORECLAD FL.

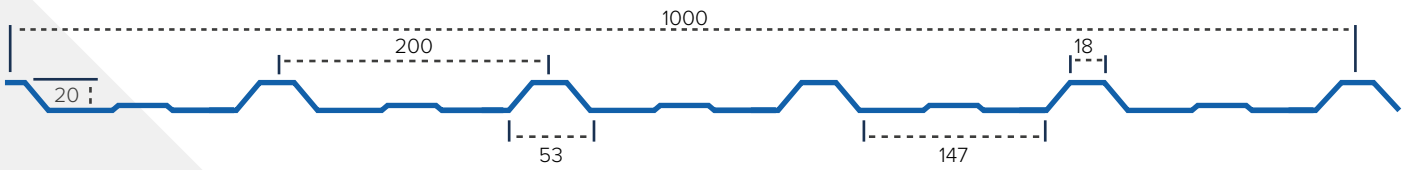

Foregale Lining Panels are available with a standard coating of white lining enamel to the exterior. Lengths of up to 6000mm can be supplied.

FORECLAD WL.

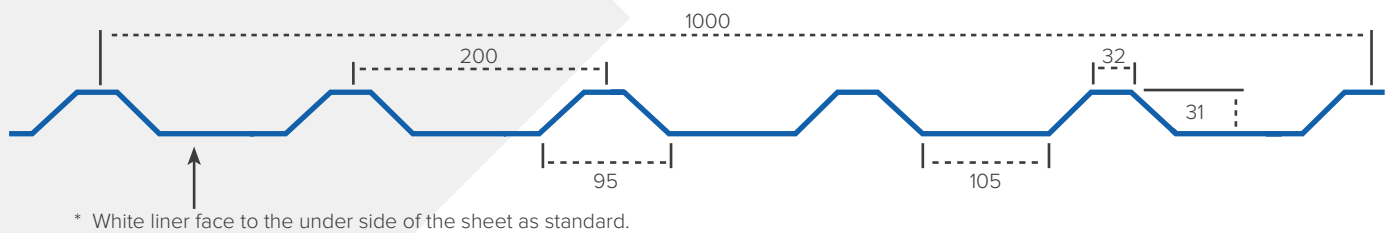

Foregale Walk on Liner panels are available with a standard coating of white lining enamel to the exterior. Longer lengths can be supplied than in a standard lining panel sheet.

DOUBLE SKIN SYSTEMS.

The lining sheet can be used in conjunction with Foregale roof and wall panels, insulation and spacers to provide a double skin cladding system.

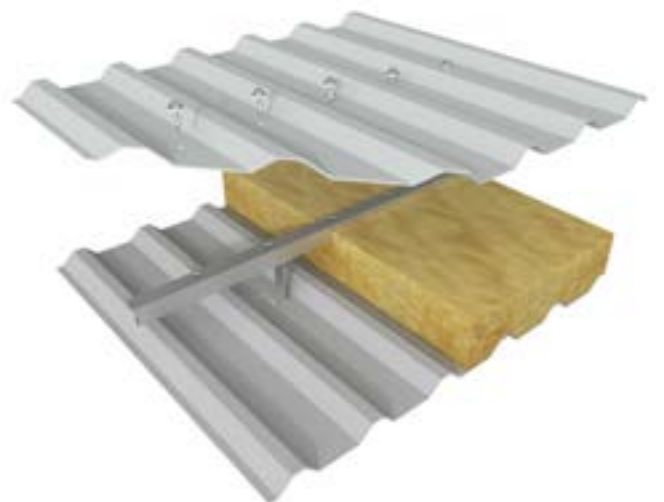

FORECLAD. GRP

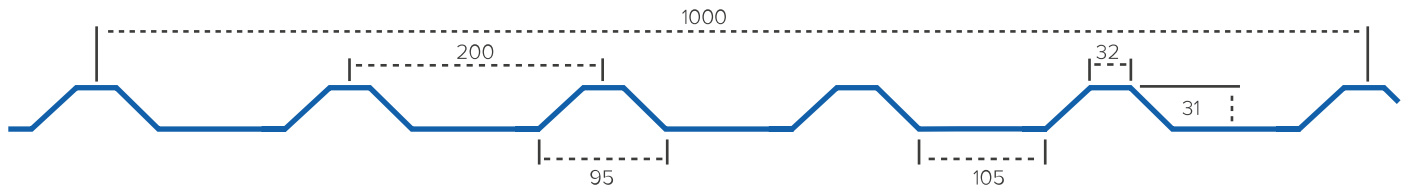

DOUBLE 6M. GRP

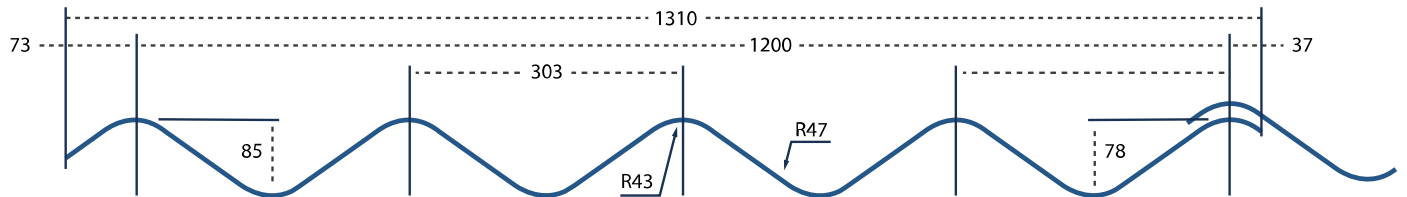

BIG 6. GRP & PVC

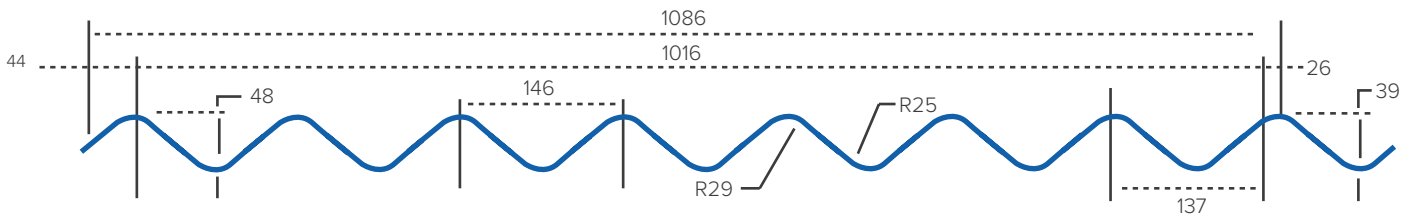

STANDARD 3. PVC

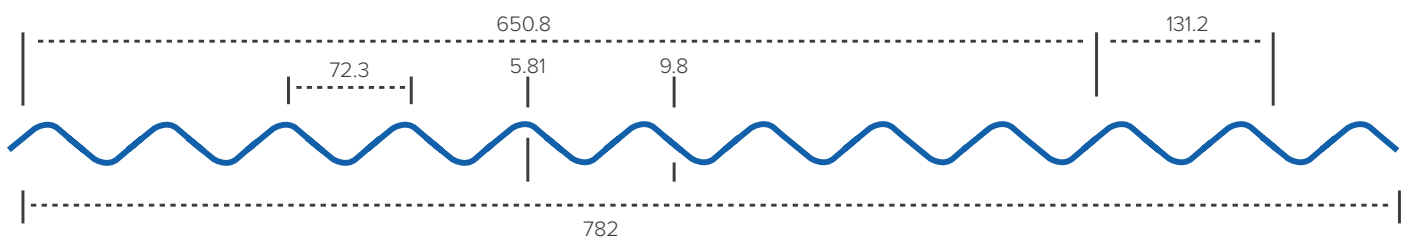

OUR FORECLAD COLOURS.

For our steel sheeting range we carry a wide variety of colours in stock, primarily covering the industry standard range. Due to our close relationships with only trusted steel mills throughout the world, it is sometimes possible to source other RAL colours too (subject to minimum quantity and varying lead times). Please get in touch with us to find out more.



INSULATED ROOFING.

Thermoclad is the high density polyurethane foam insulation sandwich panel system, designed for covering and cladding both roofs and walls. Thermoclad, with highly prominent corrugations, far apart one from the other, has been predominantly designed for building heat insulated roofing and is suitable for small to large projects.

The panel stocked at Foregale has a 30mm insulation core, it is polyester paint coated on both sides and is also steel lined! Our unique Thermoclad panels help to reduce rain noise, can be used on low pitch roofs, light weight, dramatically reduce condensation and have coated steel to both inner and outer surfaces.

* Please see website for further information on this product.



6500mm



5000mm



4000mm



3050mm

Block ended both sides

Available in Light Grey

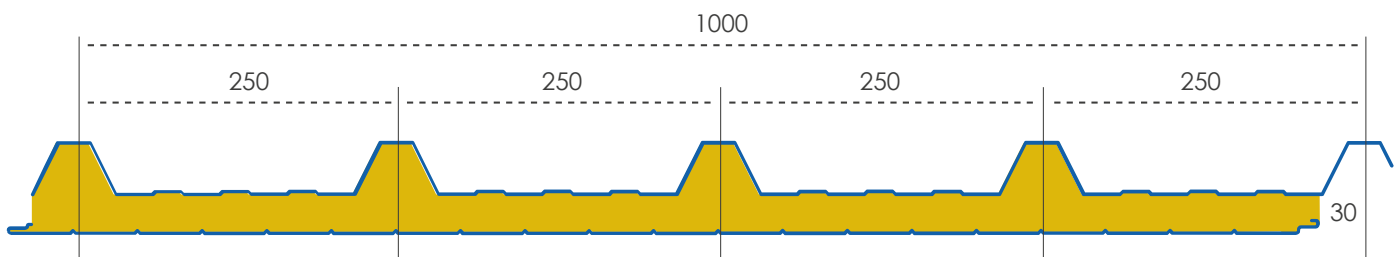

SPECIAL ORDERS.



We are also able to supply various other types of insulated panels however these may be subject to special order where lead times and costs may vary. Please call our sales team for more information.



WHAT WE OFFER.

The construction industry demands a wide and varied range of products to finish metal buildings and close the joints where building elements meet. These include everything from standard perimeter flashings to ridge closures and drip flashings. If an attractive, functional finish is needed to complete a metal building envelope then the sensible choice for flashings is Foregale.

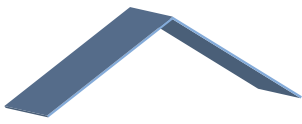
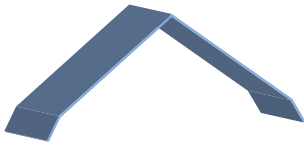
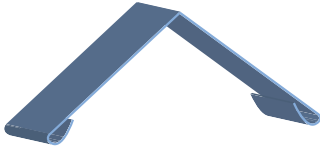
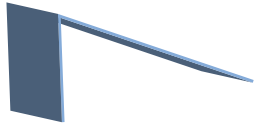
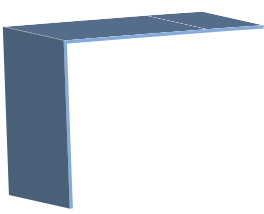
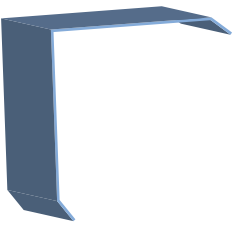
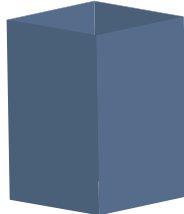
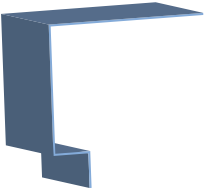
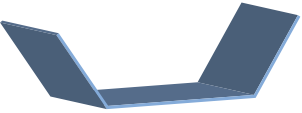
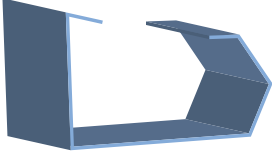
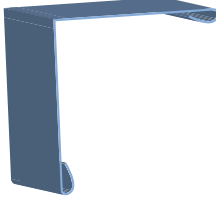
Available in a range of colours, Foregale can supply highly finished flashings that are expertly manufactured, delivered on-time and perfectly match, complement or contrast the roof and wall cladding. Ridge vents are available for ventilated constructions, especially useful to complement the DR!PSTOP condensation control fleece.

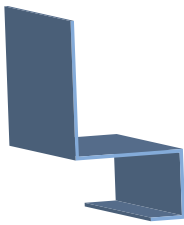
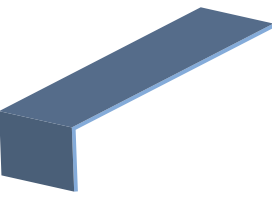
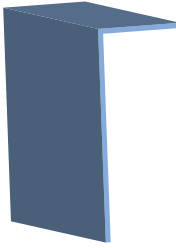
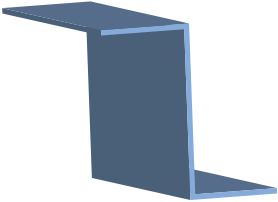
			
RIDGE	RIDGE WITH STIFFENERS	RIDGE WITH WELTS	MONO RIDGE
			
BARGEBOARD	BARGEBOARD WITH STIFFENERS	SQUARE DOWNPIPE	SHADOWLINE BARGEBOARD
			
VALLEY GUTTER	TRIMLINE GUTTER	BARGEBOARD WITH WELTS	EXPANSION JOINT
			
DRIP/CILL	EAVES	JAMB	Z SPACER FLASHING

FLAT SHEETS.

At Foregale, we also stock and produce Flat Sheets in various materials and finishes.

Plastisol 0.7mm Leather Grain

Wide colour range available
3000mm x approx. 1220mm-1250mm

Polyester 0.5mm smooth finish

Limited Colours available
3000mm x approx. 1220mm-1250mm

Galvanised 1.2mm, 1.5mm, 2.0mm

3000mm x 1250mm

Galvanised 3.0mm

2500mm x 1250mm

GALVANISED PRESSED STEEL GUTTER.

Available in 1.5mm / 2.0mm

Outlets and end caps can also be supplied.

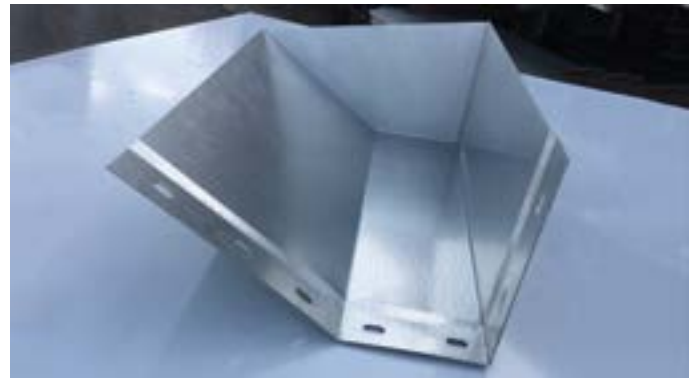

TRIMLINE GUTTER & FALLPIPE ACCESSORIES.

Trimline gutter systems give a much better look to the building. These are generally manufactured from plastisol material, usually the same material as the roof sheets that are fitted.

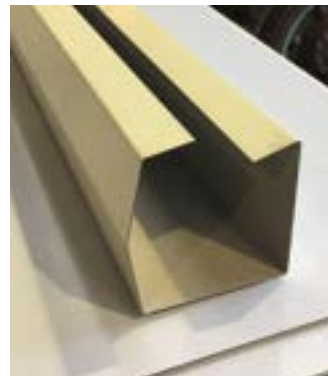

WE CAN ALSO SUPPLY.

- 150mm PVC Half Round Gutters, 110mm Round Pipes, plus associated accessories (grey as standard).
- Fatra membrane gutters.

THE ADVANTAGES.

- No more dripping from the roof.
- Durability (DR!PSTOP is not susceptible to ripping, tearing or deterioration like standard insulation and vapour barriers are).
- Easy to clean (With hose or pressure washers).

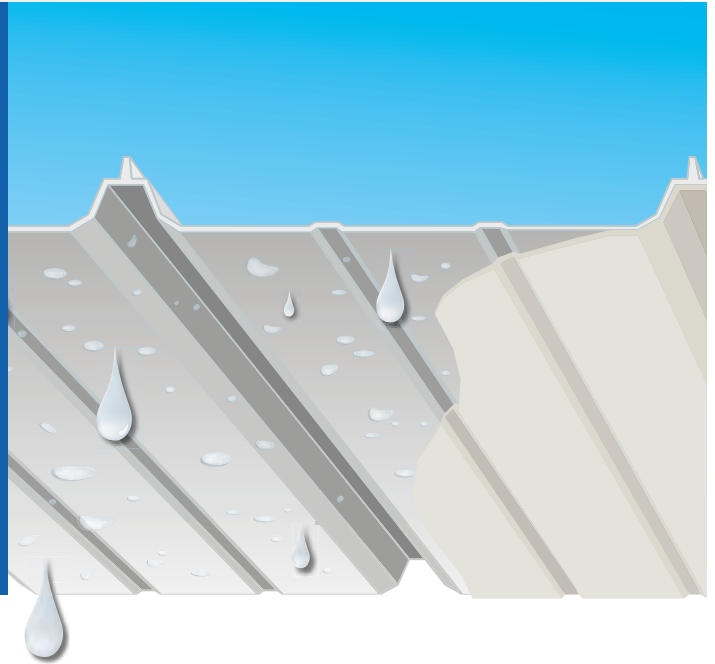

HOW DOES IT WORK?

DR!PSTOP is made of a large number of interlaced PES fibres among which there is enough space to store water drops. DR!PSTOP serves as a medium for absorbing condensed water drops

which evaporate back into the air when the temperature rises. For the process to work, good circulation (ventilation) is vitally important.

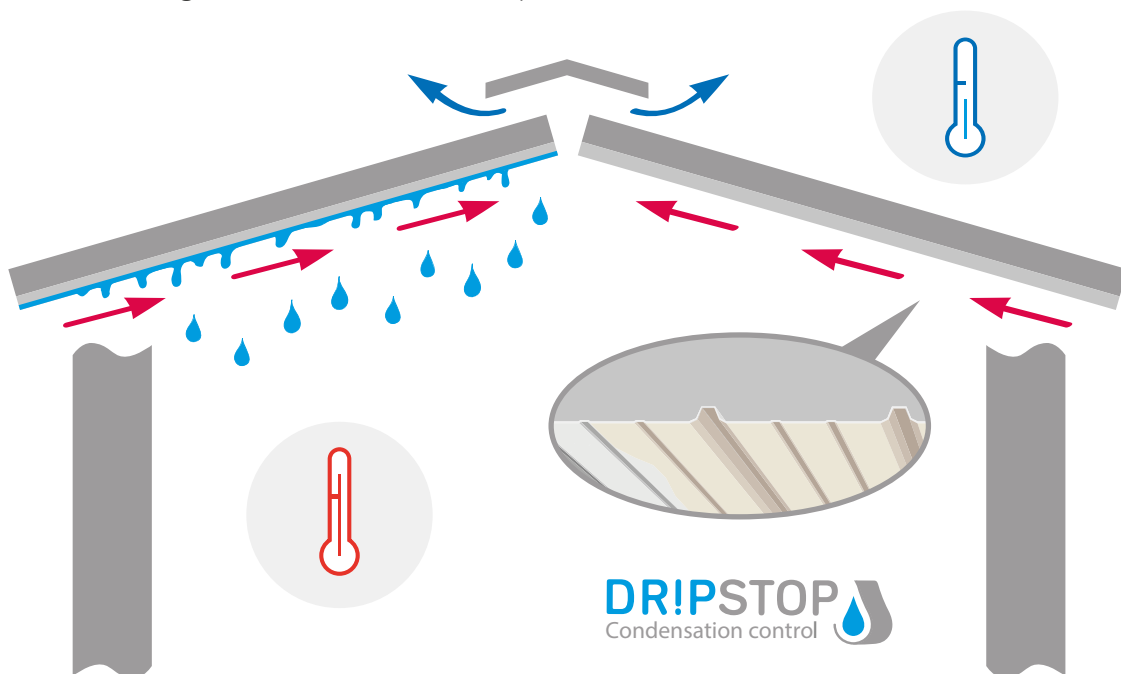

- Sports Halls
- Residential Buildings
- Garages
- Aircraft Hangers
- Warehouses
- Agricultural Buildings
- Industrial Halls
- Self Storage

PURLINS RANGE.

- Designed in accordance with BS EN 1993-1-3.
- Manufactured by cold roll forming of pre-hot dipped galvanized strip to BS EN10346 with minimum tensile strength of 450 N/mm² and Z275 coating.
- Section ranges are referenced “C” followed by three digits being the overall depth in mm.
- Individual sections are referenced “C” followed by five digits the first three being the overall depth in mm and the final two being the gross material thickness in mm multiplied by 10 - eg: a 171mm deep, 1.5mm gauge

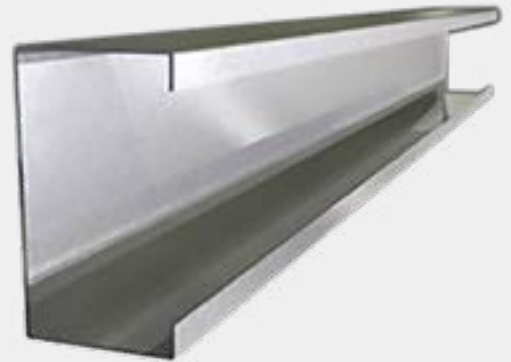

121/15

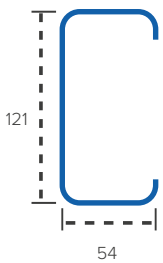

151/15

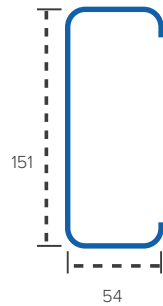

171/15

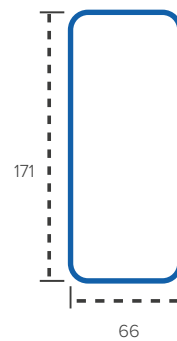

201/15

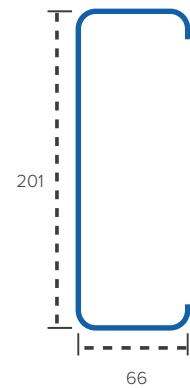

ANTI-SAG TIE



APEX TIES



DIAGONAL TIES



RAFTER STAYS



ZED PURLIN



EAVES BEAM



MINI Z SPACER BAR.



Stocked in 3MT lengths and at just 50mm deep, Mini Z spacer bars are mainly used for over cladding either an existing roof or as a frame to fix to when covering up something else such as old brick work.

They are generally a better option than timber as they tend to have a better life span. The Mini Z spacer bars are not designed for load bearing and should not be used as a replacement for a Purlin.

CLEAT DETAIL.

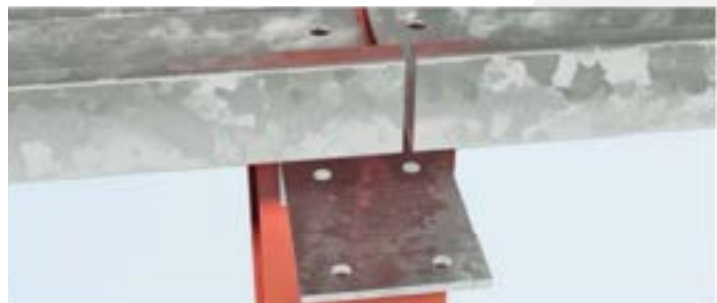
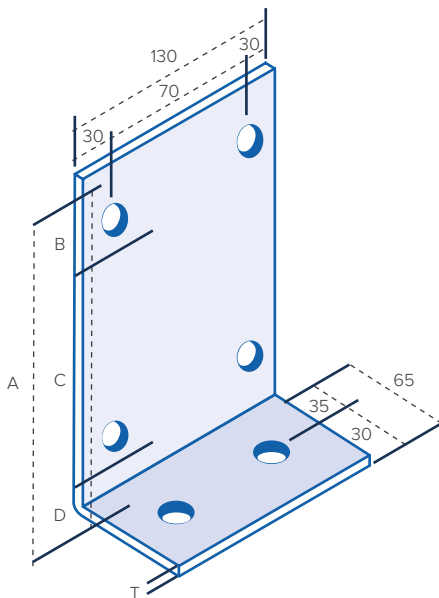

RANGE	A mm	B mm	C mm	D mm	T mm
C121	110	25	35	50	6
C151	140	25	65	50	6
C171	160	25	85	50	6
C201	190	25	115	50	6

All holes are 14mm diameter. Finish: galvanised or primer paint.

All dimensions in millimetres.

Alternative bolt on type cleats can be supplied in either Flat Plate Form or Angle (excluding bottom flange holes).

BIG 6.

Profile 6 is a high strength fibre cement sheet with polypropylene reinforcement strips inserted along precisely engineered locations which run for the full length of the sheet in each corrugation. This provides maximum reinforcement strength with no loss of disability in service.

Available in **Natural Grey**

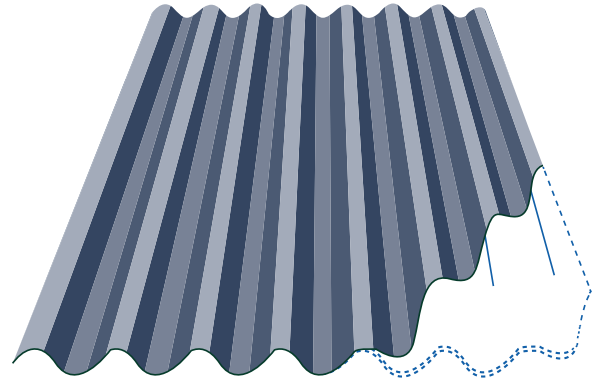

The cut-away illustration below shows the location of the polypropylene reinforcement strip inserted in a precisely engineered position in each corrugation of the Big 6 sheet.





FIXINGS.

A metal roof or wall relies on fixings to secure it to the substrate and to soundly fasten all relevant components to both the substructure and the rest of the construction. A range of different types and sizes of fixings may be required for any specific application. A thorough understanding of which fixings are most suitable for a particular construction or detail helps ensure you get the right fixings. This combined with the extensive stocks of the most popular fixings means that Foregale should be the first point of contact for high quality, low cost fixings.



INSULATION.

Foregale works with the biggest names in the insulation industry to offer the most suitable product at the most competitive price. Customers not only benefit from the convenience of a single source supply of products but also get the insulation they need at a great price that is hard to beat.



FOAM FILLERS.

The profile in cladding and roofing sheets provides strength and structural stability, however, the profiling creates gaps under any flashings at the ridges and eaves or between the sheet and the purlins. If these gaps are not filled, the envelope will not be weather tight. As well as sealing gaps against the invading elements, fillers also stop small birds entering the building and prevent dust and dirt blowing inside.



SEALANTS.

Foregale doesn't stop at supplying the major components; there are also the less conspicuous – but by no means insignificant – components that are essential to a successful installation. Sealants are an example and there is a wide range of sealants, mastics and tapes available from stock at short lead times. These can be bought and delivered separately or purchased along with the other components.

PROFILE IDENTITY FORM.

If you are in a situation where you find that you need to match up to an existing sheeting profile, without knowing the original manufacturer, you may find it challenging as there are quite a lot of different sheeting profiles out there, a lot of which are now obsolete.

Profile matched sheeting is the perfect solution for buildings where areas of box profile sheeting need replacing or adding to in the same profile.

Foregale offer a profiled sheet matching service, all we need is a sample or an accurate drawing of the full width of the sheet you want to match up to, and from this we can manufacture as many new sheets as you require up to a maximum length of 6.2MT.

In most cases, profile matched sheeting is a specialised service which involves a lot of time to allow a profile to be made by hand. This unfortunately means the price is more expensive than our standard box profile sheeting and will likely have a longer lead time.

To fabricate your profile matched sheet we recommend that you bring in a sample to ensure a higher level of accuracy when matching up. Alternatively we can manufacture from a drawing also however this is not always as accurate.

Please see below detail showing what measurements are needed on a sheet in order to identify it when sending in a drawing.

Please contact our roofing sales team if you would like to discuss profile matched sheets further.

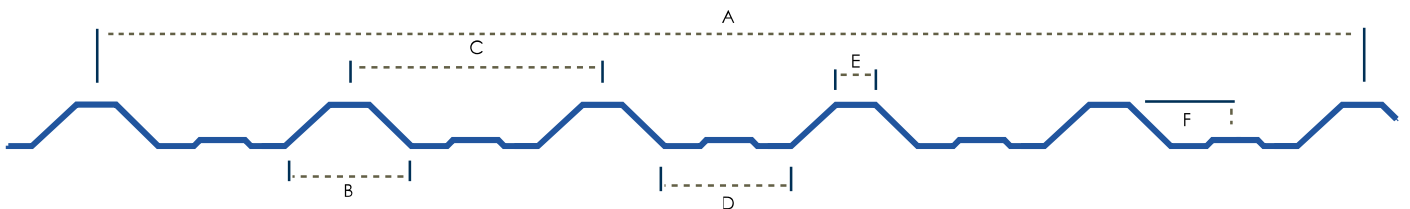

A **B** **C** **D** **E** **F**

Email Name Company

Please detail quality, length required and sheet type. Please use one line for each.

.....

.....

.....



OVER **40 YEARS** EXPERIENCE IN REINFORCEMENTS



MESH FABRIC

Fabric Reinforcement also known as steel reinforcement mesh



REBAR

Rebar, short for reinforcing bar and also known as reinforcing steel



ACCESSORIES

We supply a wide range of reinforcement accessories

Please call **01924 236980** for West Yorkshire or **01482 645488** for East Yorkshire where our expert sales team are here to answer any questions or deal with any enquiries that you may have.

THE REGION'S LEADING REINFORCEMENT SUPPLIER



911001



002

OUR STEEL REINFORCEMENTS

We're a supplier of...

- ✓ Square Mesh Fabric
- ✓ Structural Mesh Fabric
- ✓ Wrapping Mesh Fabric
- ✓ Rebar Cut & Bent to Schedule

Union Road, Liversedge, WF15 7JS | steel@foregale.co.uk

1 Livingstone Road, Hessle, HU13 0EG | hullsteel@foregale.co.uk

8.00AM – 5.00PM
MONDAY TO FRIDAY



BUILDING ON STRENGTH

www.foregale.co.uk

LIVERSEDGE DEPOT

T. 01924 236970 F. 01924 236979

Union Road, Liversedge
West Yorkshire, WF15 7JS

roofing@foregale.co.uk

HULL DEPOT

T. 01482 645388 F. 01482 644093

1 Livingstone Road, Hessle
East Yorkshire, HU13 0EG

hullroofing@foregale.co.uk



[@Foregale](https://twitter.com/Foregale)



[/Foregale](https://www.facebook.com/Foregale)



[Foregale](https://www.youtube.com/Foregale)



[foregaleuk](https://www.instagram.com/foregaleuk)

FEBRUARY 2022 EDITION

The information contained within this document is accurate to the best of our knowledge and understanding. Foregale (The Company) does not accept liability for errors or information found to be misleading. The company reserves the right to change product details and update at any time. A customer must satisfy itself that the company's products are suitable for the customer's requirements. All business is undertaken solely on the company's terms and conditions.